

DIANFLEX[®]

...simili a nessuno.



NOVITA'
NOVITA'
NOVITÀ



2019

nuovi arrivi 2019



codice 179-ZT

SANITARI VASO E BIDET CON SCARICO TRASLATO

| 179-ZT300 | BIDET TRASLATO | | | | | Listino 2019 |
|--|---|------------------|-------|------|--------|--------------|
|  | Subcode | Misura/Colore | Conf. | Imb. | Euro | NewSubCode |
| | | Scarico traslato | 1 | | 352,29 | |
| | In ceramica. Bianco | | | | | |
| 179-ZT400 | VASO TRASLATO | | | | | |
|  | Subcode | Misura/Colore | Conf. | Imb. | Euro | NewSubCode |
| | | Scarico traslato | 1 | | 352,29 | |
| | In ceramica. Bianco. Sedile non incluso. Ns art. 179-ZT900. | | | | | |
| 179-ZT900 | SEDILE PER VASO TRASLATO | | | | | |
|  | Subcode | Misura/Colore | Conf. | Imb. | Euro | NewSubCode |
| | | Bianco | 1 | | 130,10 | |

OBJECT: BIDET TRASLATO

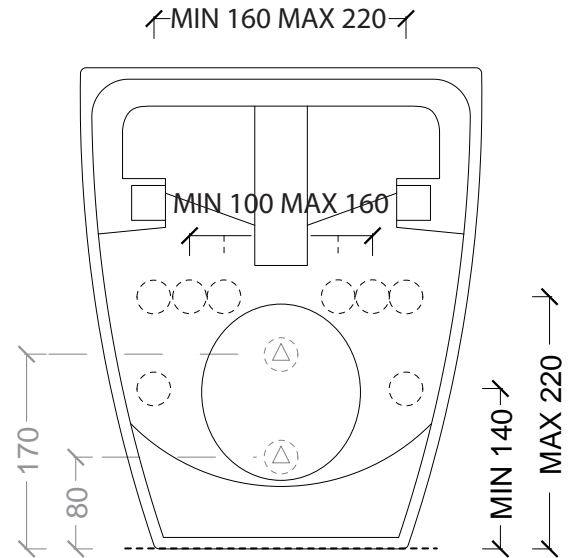
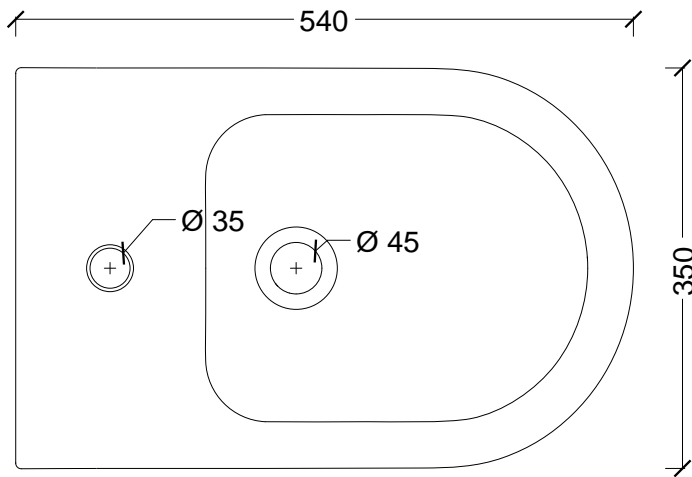

- RANGE UTENZA ACQUA
- MONTAGGIO STANDARD RANGE MIN 100 MAX 160 mm
 - MONTAGGIO CON KIT RANGE MIN 160 MAX 220 mm (kit da richiedere in fase d'ordine)
 - RANGE DI MOVIMENTO UTENZE ACQUA CALDA E FREDDA IN ALTEZZA MIN 140 MAX 220 mm
- RANGE SCARICO
- RANGE DI MOVIMENTO ALTEZZA CENTRO SCARICO DEL SIFONE MIN 80 MAX 170 mm

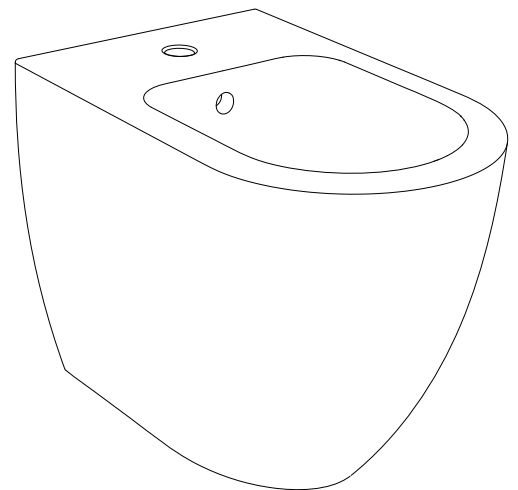
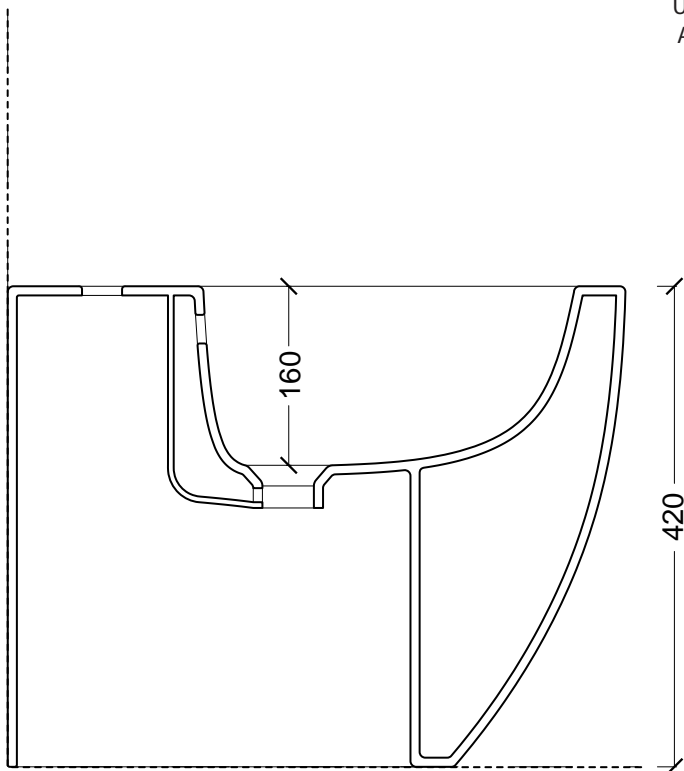

OBJECT: VASO RIM. TRASL.

